



IP Office

5420/2420 Phone User Guide

Table of Contents

The Telephone	4
Overview.....	4
Call Appearance Keys	6
Call Appearance Keys Icons	7
System Features	7
Basic Call Handling Features	8
Answer a Call	8
Make a Call.....	8
Clearing a Call	9
Headset Working	9
Speakerphone	10
Speed Dial	10
Redial	10
Mute.....	11
Hold	11
Transfer	12
Conference.....	13
Message	13
Using Speed Dials	14
Overview of Speed Dials	14
Dialing a Speed Dial Number	14
Deleting a Speed Dial.....	15
Editing a Speed Dial	15
Converting a Call Log Entry to a Speed Dial	15
Adding a New Speed Dial.....	16
Using the Call Log	17
Overview of the Call Log	17
Using The Call Log	18
Viewing the Call Log.....	18
Making Calls from the Call Log.....	18
Saving a Call Log Entry to Your Speed Dial List	18
Deleting a Call Log Entry	19
Erasing All Logged Calls	19
Setting Which Calls are Logged	19
Changing Options	20
Changing Ringer Options	20
Adjusting the Display Contrast	21
Call Log Setup	21
Miscellaneous.....	21
Using Self Test	21
Selecting the Display Mode	21
Default Phone/Erase All Settings	22
Language.....	22
Automatic Gain Control (AGC)	23
System Features	24
System Features	24
Making Calls	24
Answering Calls.....	24
Call Forwarding	25
Diverting Calls	25
Do Not Disturb	25
Voicemail	26
Default Feature Codes	27

EU24 Expansion Module	28
EU24 Overview.....	28
Connection	29
Using the EU24 Expansion Module.....	30
Viewing the Alternate Display	30
Selecting a Call Appearance/Feature Button.....	30
Understanding Call Appearance/Feature Button Status Icons	30
Index.....	31

The Telephone

Overview

This guide covers the use of the Avaya 5420 and 2420 phones on Avaya IP Office. Both phones are similar, however the 5420 is only supported on the IP Office whereas the 2420 is supported on a range of Avaya phone systems.



1. **Display, Call Appearance and Feature buttons:** Call Appearance Keys allow the user to handle multiple calls and the display shows call information. Details on system features (allocated by your System Administrator) can also be displayed.
2. **Message lamp:** Lit when the user has voicemail messages. Can also be set to flash when the phone is ringing.
3. **◀ ▶ Previous/Next Page:** Move through the different pages of the call handling, speed dials and call log screens. Also used to move the cursor during data entry.
4. **✉ Messages:** Access the user's mailbox.
5. **Call Handling Buttons:**
 - **☎ Hold:** Place call on hold.
 - **↔ Transfer:** Transfer call.
 - **☎☎☎ Conference:** Conference held calls.
 - **⏏ Drop:** Drop call.
 - **☎☎☎ Redial:** Redial last number dialed.
6. **Dial pad:** Standard 12-button pad for dialing telephone numbers.
7. **▼▲ Volume Controls:** Adjust the speaker, handset, headset, or ringer volume depending on which is currently in use.
8. **🔇 Mute:** Turns the microphone on/off. When in use, the associated light is on and the caller cannot hear you.
9. **🎧 Headset:** Switches from handset to headset. The light associated with this button turns on when the headset is active.
10. **🔊 Speaker:** Access the speakerphone. The light associated with this button turns on when the speakerphone is active.
11. **→🏠 Exit:** Returns you to the main call handling screen.
12. **Softkeys:** Used to navigate to or initiate certain features, such as Speed Dial or Call Log, as well as control certain actions within the features. These keys correspond to the text prompts in the display screen immediately above them.

Call Appearance Keys

Normally, the first page of the main call handling screen contains three keys set as 'call appearance' keys. These are allocated to you by your System Administrator and are indicated as **a=**, **b=** and **c=**.

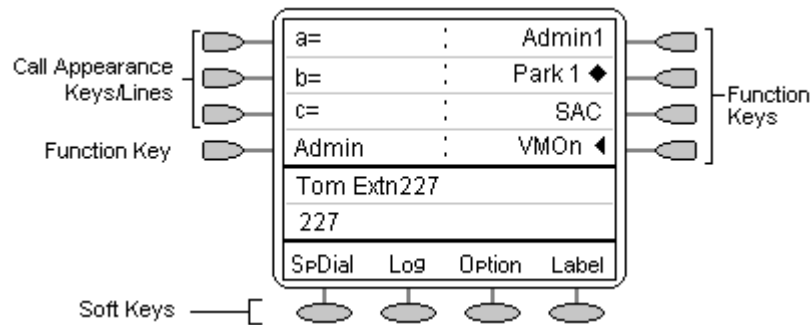

Your System Administrator can change a call appearance key with:

- **A Bridged Appearance**
A bridged appearance key matches the status and operation of the Call Appearance Key on a pre-defined colleague's telephone. Hence, you can pick-up, make and receive calls on behalf of your colleague.
- **A Line Appearance**
An IP Office exchange line (but not IP lines) can be allocated to you such that the status of that line is displayed and you can use the line appearance key to make and receive calls.
- **Call Coverage Appearance**
A call coverage appearance key alerts you when a pre-defined colleague is receiving a call. The covered user does not need to be using call appearance keys. Hence, you can pick-up calls on behalf of your colleague.

All of the above can only be allocated to you by your System Administrator.

For details of Bridged, Line and Call Coverage Appearance Keys set-up and their operation, refer the IP Office Key and Lamp Operation manual.

CAUTIONS:















1. Having more than two Call Appearance keys is very useful. When holding a call you can answer/make another call and then switch between calls or transfer or conference. If you are set to receive call waiting indication, the waiting call is shown against the next call appearance key.
2. Although the System Administrator can replace the Call Appearance Keys with:
 - A Bridged Appearance
 - A Line Appearance
 - Call Coverage Appearance
 - System Features

This would severely restrict the use of features such as conference and transfer.

It is for these reasons that it is **strongly recommended** that all Call Appearance keys **remain at their default settings**.

Call Appearance Keys Icons

The icons displayed against the Call Appearance/Feature Keys allow you to determine the status (for example, on **Hold**) of each call. Icons also indicate whether a feature has been activated for a particular button.

- **Incoming Call:** 
A  symbol next to a call appearance key indicates an incoming call. Pressing the adjacent   key answers the call and puts any other current call on hold.
- **Connected:** 
A  symbol next to a call appearance key indicates that it is the currently connected call. The caller's telephone number (if available) is also shown. Pressing the adjacent   key puts the call on hold. An **H** is also shown on the display.
- **On Hold:** 
A  symbol next to a call appearance key indicates a call on hold. Pressing the adjacent   key takes the call off hold and puts any other current call on hold.
- **Function Active:**  
The button to the left or right of the function key is active.

System Features

System Features **can only be set** against soft Function Keys by your System Administrator. However, your System Administrator may allocate you two 'self administrator' features that will enable you to add System Features to your soft Function Keys.

In addition, there are a number of System Features that **you can always access yourself** by the use of short codes. Refer to System Features Introduction for details of System Features that you can always access yourself by dialing short codes, for example ***17** to listen to your voicemail messages.

Basic Call Handling Features

Answer a Call

When a call arrives at your phone, you hear a ringing tone and a blinking bell icon appears on the associated call appearance.

To answer an incoming call





Do one of the following:

- If you are not active on another call, answer the call using your handset, headset, or speakerphone (see Speakerphone).
- If you are active on a call already, place the active call on hold (Hold), and then answer the incoming call.
- If the call appearance for the ringing call is not displayed on the current screen page, use  **Exit** to return to the first page of the Home screen. When you locate the call appearance for the ringing call, press the corresponding call appearance button.

Make a Call

You can make calls from the phone using a variety of methods as follows:

To manually make a call:



1. Dial the required number on the key pad (remember to include the required access code (for example, 9) for an outside line) and listen to the progress of the call.
2. Adjust speakerphone volume as necessary.
 - To change the volume use the  and  buttons. The display shows the volume level. (There are eight volume levels.)
3. If the call is not answered, you can clear the call by pressing  **Speaker** or  **Drop**

or

4. When the call is answered, either speak or pick up the handset and speak to the called party.

To automatically make a call:

Do any of the following:

- Press  Redial and a call appearance key  to have the phone dial the last number that you dialed. See Redial.

or

- Access the Call Log and initiate a call to a specific entry. See Making Calls from the Call Log.

or

- Access the Speed Dial List in your personal directory and initiate a call to a specific entry. See Dialing a Speed Dial Number.
- When the call is answered, either speak or pick up the handset and speak to the called party.

Clearing a Call

To clear an established call either:

1. Replace the handset

or

2. Press  **Drop**. You will hear dial tone, unless you are in 'call center mode' of working when you will then hear silence.

Headset Working

When a headset is to be used, it must be plugged in to the headset socket on the base of the phone. To activate the headset and switch off the handset, press  **Headset**. The lamp beside the button is illuminated when headset working is activated.

To answer an incoming call:

1. Press the call appearance key  next to the flashing bell icon ():

To clear a headset call:



1. Press  **Drop**.

To manually make a call:

1. Dial the number (remember to include the required access code (for example, 9) for an outside line) and listen to the progress of the call.

To automatically make a call:

Do any of the following:

- Press  Redial and a call appearance key  to have the phone dial the last number that you dialed. See Redial

or

- Access the Call Log and initiate a call to a specific entry. See Making Calls from the Call Log.



or

- Access the Speed Dial List in your personal directory and initiate a call to a specific entry. See Dialing a Speed Dial Number.
- When the call is answered, speak to the called party.

Speakerphone

The two-way built-in speakerphone allows you to make and answer calls without lifting your handset. Keep in mind that two-way speakerphones may not operate satisfactorily in every environment (such as in very noisy locations).

To make or answer a call without lifting the handset, or to use the speakerphone with any feature

1. Press  **Speaker**. The LED beside the button illuminates.
2. Make or answer the call, or access the selected feature.
3. Adjust the speakerphone volume if necessary. To change the volume use the  and  buttons. The display shows the volume level. (There are eight volume levels).

To change from the speakerphone to the handset (or headset if fitted)

1. Pick up the handset (or press  **Headset**) and talk.

To change from the handset to the speakerphone

1. Press  **Speaker**.
2. Hang up the handset.



To end a speakerphone call

1. Press  **Speaker** again.

Speed Dial

The Speed Dial feature allows you to have the phone automatically dial calls to telephone numbers stored in your personal directory (maximum of 104). See Dialing a Speed Dial Number.

To make a call to a personal directory entry using the Speed Dial feature



1. From the Home screen, press the  **SpDial** softkey. The **Speed Dial** screen is displayed.
2. Press the button next to the entry you want to call.
3. If the entry you want is not displayed, use  and  to cycle through the entries **or** key the first letter of the required name to jump to the page with a matching entry.
4. The phone dials the number for you.

Redial

The Redial feature automatically redials a previously dialed extension or outside number (up to 24 digits). Your phone stores the last ten numbers dialed.

Note: If you have dialed the same number twice in succession, it will only have one appearance in the redial list.



To redial previously dialed number:

1. Press  **Redial**. Use  and  to step through the entries. When you have located the required number, press the associated key.

Mute

During an active call, the Mute feature prevents the party with whom you are speaking from hearing you. This feature is most commonly used in conjunction with the Speakerphone, but can be used to hold an off-line conversation at any time during a call.





Preventing the other person on the line from hearing you:

1. Press  **Mute**. The other party cannot hear you. The indicator next to the Mute button lights when Mute is active.
2. To reinstate two-way conversation, press  **Mute** again.

Hold



If, with a call in progress, a second call arrives and is shown against a Call Appearance key, you can then Hold the first call and answer the second call.

To put an existing call on hold:

1. Press  **Hold** or the Call Appearance button with the  symbol against it. The symbol changes to ; showing that the line is on hold.
2. Answer the second call by pressing the Call Appearance button with the  symbol against it. The symbol changes to ; showing that the line is connected.

To return to the held call:

1. If you have a call in progress, then first put that call on hold as above.
2. To retrieve a held call, simply press the Call Appearance button with the  against it.

Note: After a pre-set time (defined by your System Administrator), you are reminded that you have a call on hold by the  hold icon changing for a few moments to  and the phone ringing.

Transfer

The Transfer feature allows you to transfer a call from your telephone to another extension or outside number.

To transfer the current call to another extension:

1. With a call in progress, press **↔Transfer** or **⏸ Hold**.
2. When you hear dial tone, dial the number to which the call is to be transferred.
3. Do one of the following:
 - To transfer the call without announcing it, either hang up or press **↔Transfer** again. The transfer is complete. If the transferred call is not answered within a preset time, it is returned to you.
 - To announce the call before transferring it, wait for the called party to answer.
 - If the called party is willing to accept the call, press **↔Transfer** again to complete the transfer.
 - If the called party does not wish to accept the call, press **⏸ Drop**. You can return to the held call by pressing its call appearance button.
 - If the line is busy or if there is no answer, press **⏸ Drop**. You can return to the held call by pressing its call appearance button.

To transfer a new call to a held call using Conference:

1. With a call in progress and you wish to make an enquiry call or another call arrives, press **⏸ Hold**. Make or answer the second call. The second call requires to be transferred to the first held call.
2. To transfer the new call to the held call, press **☎Conference** and then **⏸ Drop**. The transfer is complete.

Conference

The Conference feature allows you to conference other parties (including yourself) into a call.

Notes:

1. The number of parties allowed in a conference is controlled by your telephone system.
2. Two Call Appearance keys are required for the conference feature.

To add another party to a call:

1. Press **☎Conference**
2. Dial the number of the person you want to add to the call.
3. Wait for an answer. If the called party does not answer or does not want to join the conference, press **☎Drop**.
4. To add the person to the call, press **☎Conference** again. You can return to the held call by pressing its call appearance button.
5. Repeat steps 1 through 4 for additional conference connections.

To add a held call(s) to an active call:

1. Press **☎Conference**.
2. All held calls are added to the conference.

To leave a conference call:

1. To leave a conference, press **☎Drop**.

Message

Your Message lamp turns on when a caller has left a message for you.

Press the  **Message** button to retrieve your messages, and follow the prompts.

Using Speed Dials

Overview of Speed Dials

The phone can store up to 104 personal speed dials. The list of these speed dials is accessed by pressing **SpDial**. If **SpDial** is not shown, press **Exit** to exit the current screen.

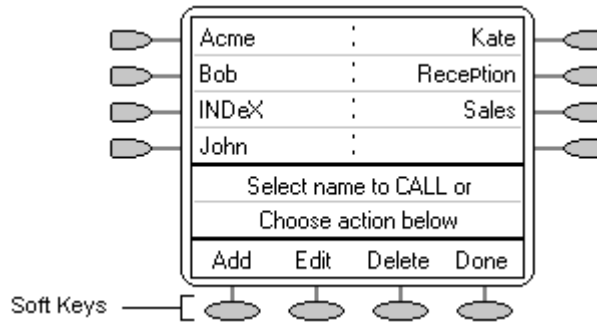

- The speed dial list is sorted alphabetically.
- Press **Left** and **Right** to move between pages.
- Press the appropriate letter key to move direct to the first page with a matching name.
- Press the **Call** or **Speed Dial** key next to an entry to call the associated number.
- Use the **Soft Keys** to perform other actions.

Pressing **Add** or **Edit** gives access to the details of a particular speed dial.

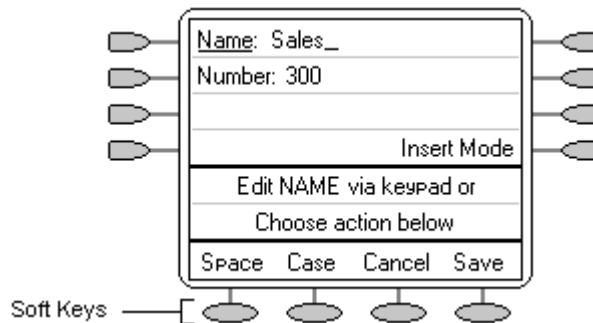

Note: Speed dials can be used for any numbers that can be manually dialed from the extension. Where a dialing prefix is required (for example an external line access digit; usually 9) then that prefix must be part of the speed dial number.

Dialing a Speed Dial Number

You can use the speed dial directory to make a call with the handset on hook or off hook.

1. Press **SpDial**. If **SpDial** is not shown, press **Exit** to exit the current screen.
2. Press **Left** and **Right** to display different pages of speed dials **or** key the first letter of the required name to jump to the page with a matching entry.
3. When the required entry is displayed, press the adjacent **Call** or **Speed Dial** key.

Deleting a Speed Dial

1. Press **SpDial**. If **SpDial** is not shown, press **→** to exit the current screen.
2. Press **Delete**.
3. Select the speed dial entry you want to delete. Press **◀** and **▶** to display different pages of speed dials **or** key the first letter of the required name to jump to the page with a matching entry.
4. When the required entry is displayed, press the adjacent **⏪** or **⏩** key. A request for confirmation will appear.
5. Press **Yes** to delete the entry or **Cancel** to exit without deleting.
6. Select another entry to delete or press **Done** to return to the speed dial list.

Editing a Speed Dial

1. Press **SpDial**. If **SpDial** is not shown, press **→** to exit the current screen.
2. Press **Edit**.
3. Select the speed dial entry you want to edit. Press **◀** and **▶** to display different pages of speed dials **or** key the first letter of the required name to jump to the page with a matching entry.
4. When the required entry is displayed, press the adjacent **⏪** or **⏩** key.
5. Edit the speed dial using the same methods as for adding a new speed dial. See Adding a New Speed Dial.
6. After saving or canceling any changes you will be returned to the speed dial selection list. Select another speed dial to edit or press **Done** to return to the speed dial list.

Converting a Call Log Entry to a Speed Dial

You can create a new speed dial from a call log entry. See Saving a Call Log Entry to Your Speed Dial List.

This process will start the normal speed entry screen but pre-filled with the name and number from the call log entry.

Adding a New Speed Dial

1. Press **SpDial**. If **SpDial** is not shown, press **Exit** to exit the current screen. Press **Add**. If a message stating that the speed dial list is full appears, you must first delete an existing entry before adding any new entry. See [Deleting a Speed Dial](#).

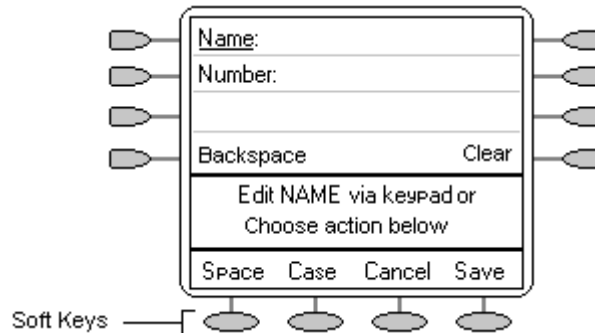

- You can switch between **Name** and **Number** entry by pressing the **Left Arrow** key next to the item you want to edit. The **Soft Keys** options also change accordingly.
2. With **Name** selected, begin entering text using the telephone keypad. Each key is marked with the letters and number it provides. You may have to press the key more than once depending on the character you require.
 - For example, the key **2** is also marked as **A**, **B** and **C**. To enter a **C**, press **2** until a **C** is displayed.
 - If the next character you want to enter is on the same key, press **Right Arrow** to move the cursor right and then enter the character.
 - By default the first letter is entered in upper-case and the phone then switches to lower-case entry mode. To change the case of the current character press **Case**.
 - To enter a space press **Space**.
 - If you make a mistake, use **Backspace** to delete the character to the left of the cursor.
 - If you have made a mistake in the middle of a character string and do not wish to backspace and re-enter all the characters, use the **Left Arrow** key to step back to one character before the point where you wish to edit. Either insert the new character or press **Backspace** to delete the character to the left of the cursor.
 - Pressing the ***** key once enters a **.** (period) or twice a *****. To enter more than one ***** or period, press **Right Arrow** to move the cursor to the right and then enter the character.
 - Pressing the **#** key once enters a **-** (dash) or twice enters a **#**. To enter more than one **#** or dash, press **Right Arrow** to move the cursor to the right and then enter the character.
 3. When the name is set as required, select **Number**.
 4. Enter the number required using the dialing keypad. For external numbers remember to enter any external dialing prefix required (9 say).
 - To enter a hyphen, press **Hyphen**. This does not affect the number dialed but may help make numbers more readable.
 - To enter a 1.5 second pause, press **Pause**. This will appear as a **,** (comma) character in the telephone number.
 - Use the **Left Arrow** and **Right Arrow** keys to move the cursor left or right.
 5. To save the speed dial and return to the speed dial list, press **Save**.
 6. To return to the speed dial list without saving the changes press **Cancel**.
 7. To return to the call handling screen without saving the changes press **Exit**.

Using the Call Log

Overview of the Call Log

The phone maintains a call log, accessed by pressing  **Log**. This log can store up to 100 entries. These can be a combination of incoming answered calls, incoming unanswered calls and outgoing calls

You can select which types of calls are included in the log. You can also use call log entries to make return calls or convert the entry into a speed dial for future use.





- **⚠WARNING:**
Calls that are made using pin codes and other information will appear in the call log. Either Logging of outgoing calls should be switched off or those call logs removed manually. See Setting Which Calls are Logged.

Notes:

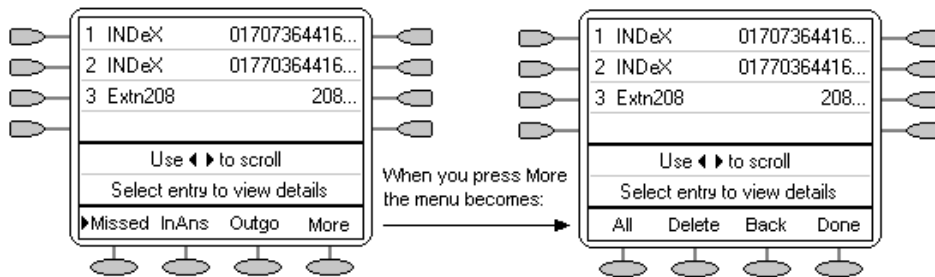

1. Only outgoing calls made using the dial pad or a **SpDial** entry are logged.
2. Call log entries are lost if the phone is disconnected from the IP Office.

When  **Log** is pressed a screen similar to the following is displayed:

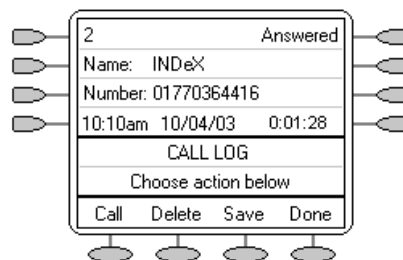

- **Missed** calls are displayed first. You can select from **InAns** or **Outgo**. Alternatively, press **More** and select **All** to display all three options.
- Logged calls are shown with the most recent first.
- The name of the called or calling party is shown if available.
- The number of the called or calling party is shown.
- Press  and  to display further pages of entries.
- Pressing the  or  key next to a log entry display further details of that particular call.



- The number of the log entry
- The type of log entry, i.e. **Answered**, **Un-answered** or **Outgoing**.
- The name of the called or calling party is shown (if available).
- The number of the called or calling party is shown.
- The date and time of the call.
- Press  and  to display the previous or next logged call.
- The  keys provide a number of actions.

Using The Call Log

You can make calls directly from the call log. Whilst in the call log you can still make a call by going off-hook, pressing **Speaker** and dialing a new call. Similarly, you can still receive calls and handle them using the dial pad key functions.

Viewing the Call Log

1. Press **Log**. If **Log** is not shown press any soft key
 2. At default, **Missed** calls are displayed first. You can select from **InAns** or **Outgo**. Alternatively, press **More** and select **All** to display all three options. To return to **Missed** or **InAns** or **Outg**, press **Back** and make your selection.
 3. Press **◀** and **▶** to display different pages of log entries.
 - To exit the call log and return to the previous screen press **Done**.
 - To exit the call log and return to the call handling screen press **→**.
 - To view the details of a particular log entry, press the **⏏** or **⏏** key next to the entry.
 4. Press **Done** to return to the previous screen.
-

Making Calls from the Call Log

1. Press **Log**. If **Log** is not shown press any soft key
 2. At default, **Missed** calls are displayed first. You can select from **InAns** or **Outgo**. Alternatively, press **More** and select **All** to display all three options. To return to **Missed** or **InAns** or **Outg**, press **Back** and make your selection.
 3. When you locate the entry you want to call, press the **⏏** or **⏏** key next to the entry.
 4. Press **Call** make the call.
 - If the number shown is external but doesn't include the external dialing prefix used by your telephone system, go off-hook, dial the prefix and then press **Call**.
-

Saving a Call Log Entry to Your Speed Dial List

1. Press **Log**. If **Log** is not shown press any soft key
2. At default, **Missed** calls are displayed first. You can select from **InAns** or **Outgo**. Alternatively, press **More** and select **All** to display all three options. To return to **Missed** or **InAns** or **Outg**, press **Back** and make your selection.
3. Press **◀** and **▶** to display different pages of log entries.
4. When you locate the entry you want to call, press the **⏏** or **⏏** key next to the entry.
5. Press **Save**. The speed dial editing screen appears, pre-filled with the details from the call log entry. See Adding a New Speed Dial.

Deleting a Call Log Entry

1. Press **Log**. If **Log** is not shown press any soft key
2. At default, **Missed** calls are displayed first. You can select from **InAns** or **Outgo**. Alternatively, press **More** and select **All** to display all three options. To return to **Missed** or **InAns** or **Outg**, press **Back** and make your selection.
3. Press **◀** and **▶** to display different pages of log entries.
4. When you locate the entry you want to call, press the **☐** or **☐** key next to the entry.
5. Press **Delete**. The entry is deleted from the Call Log and the details of the next call are shown.
6. To exit the call log and return to the call handling screen press **→☐ Exit**.

Erasing All Logged Calls

Loss of power to the phone will cause all call log entries to be deleted.

The Erase All option deletes the calls you have selected to log. See Setting Which Calls are Logged.

Caution: This action also deletes all speed dial entries and phone personalization options. See Default Phone/Eraser All Settings.

1. Press **Log**, followed by **More**.
2. Press **Delete**. You are presented with a message asking you to confirm that you want to delete all entries.
3. Press **Erase** to remove all logged entries

Setting Which Calls are Logged

Caution: If you change these settings, any call details already in the call log that no longer match the selection are deleted.

1. Press **Option**. If **Option** is not shown, press **→☐** to exit the current screen.
2. Press **Log Setup**.
A menu showing **Answered**, **Un-Answered** and **Outgoing**, with their current settings, is displayed.
3. To toggle a particular setting between **Yes** or **No**, press the **☐** key next to it. Alternatively, press the **☐** key next to a call type to underline its current setting and then press **Yes/No** to change the value of the currently underlined setting.
4. Do one of the following: **Note:** If you press **Save** after changing the settings, any existing call log entries that do not match the call types selected are deleted from the call log.
 - To save the settings and return to the options menu, press **Save**. You will hear a confirmation tone.
 - To return to the **Options** menu without saving any changes, press **Cancel**.
 - To return to the call handling screen without saving any changes, press **→☐ Exit**.

Changing Options

Changing Ringer Options

The IP Office uses 'distinctive ringing' for different types of calls - a repeated single ring for internal calls, a repeated double ring for external calls and a single ring followed by two short rings for ringback calls. These options are fixed by the IP Office. The phone's own menus allow its ringer sound to be personalized so you can recognize it from other ringing phones.

To change the ringer sound:

You can choose from among eight different ring sounds. This alters the tone and style of ringing used by the phone, the ring pattern is still controlled by the IP Office according to the call type. Note: If you receive a call while selecting a ringer sound, you are automatically returned to the call handling screen.

1. Press **→** **Exit** to exit any other mode, then press any of the  keys below the display.
2. Press **Option**.
3. Press **Ring Options** followed by **Ring Pattern**. A menu with the current ring pattern appears.
4. To select a ringing pattern use either the **◀** and **▶** keys or press a dial pad key between 1 and 8. You will hear the selected ringing pattern.
5. To hear the ringing pattern again press **Play** or repress the dial pad key.
 - When you have selected a ringing pattern, press **Save**. You will hear a confirmation tone and be returned to the options menu.
 - If you want to return to the options menu without changing the ring pattern, press **Cancel**.

To use the Message Lamp for ringing alerts:

1. Press **→** **Exit** to exit any other mode, then press any of the  keys below the display.
2. Press **Option**.
3. Press **Ring Options** and set **Flash Message Lamp** to **Yes** or **No**. When set to **Yes** the Message lamp will flash when you receive a call.
 - Changing this option does not affect the voicemail visual indicator feature.

To automatically show the call handling screen:

1. Press **→** **Exit** to exit any other mode, then press any of the  keys below the display.
2. Press **Option**.
3. Press **Ring Options** and set **Show Phone Screen** to **Yes** or **No**. If set to **Yes** then, when you are setting up/using Speed Dial, Call Log, etc, you are automatically returned to the call handling screen when you receive a call.

Adjusting the Display Contrast

You can adjust the contrast level on the telephone display. You can choose from among fifteen levels of contrast.

1. Press **→** **Exit** to exit any other mode. Press **Option**.
2. Press **Contrast**. A menu with the current contrast setting appears.
3. Use the **◀** and **▶** keys to adjust the level of contrast.
4. When the contrast is set as required, either:
 - Return to the options menu by pressing **Done**.
 - Return to the call handling screen by pressing **→** **Exit**.

Call Log Setup

Through the **Option** menu you can specify which types of calls should be included in the phone's call log. See Setting Which Calls are Logged.

Miscellaneous

This option only contains one menu item: **Stay in Speed Dial**.

When set to **Yes** and you access your personal Speed Dial list the menu will remain displayed regardless of any calls made or received.

1. Press **→** **Exit** to exit any other mode. Press **Option**.
2. Press **Miscellaneous** and set **Stay in Speed Dial** to **Yes**.

Using Self Test

Self test can be used to display information about the phone and to check operation of the lamps and display. The information may be required by a telephone system maintainer.

1. Press **→** **Exit** to exit any other mode. Press **Option**.
2. Press **Self Test**. The a screen of information appears.
3. Press and hold the **Test** key. The screen lines should all go black and all the phone lamps should come on.
4. Do one of the following:
 - To return to the options menu, press **Done**.
 - To return to the call handling screen, press **→**.

Selecting the Display Mode

See Display Mode.

Default Phone/Erase All Settings

The Erase All option allows you to reset all personalized settings entered through the phone's Option menus (except contrast level). It also deletes all entries in the phone's Call Log and Speed Dial lists.

1. Press **→** **Exit** to exit any other mode. Press **Er** **Erase...**
2. Press the **Er** key next to an item to select/de-select it for erasure. A **◀** is shown next to selected items. The items selectable for erasure are:
 - **Speed Dials:** Selects for erasure all speed dials set in the phone's **SpDial** store.
 - **Call Log:** Selects for erasure all entries in the phone's call log.
 - **User Labels:** Selects for erasure all customized function key labels.
 - **Language:** Selects to default the phone's language setting back to default.
 - **Options:** Any for erasure or defaulting all other phone options.
 - **All:** Selects for erasure or defaulting all of the above.
3. Press **Er** **Erase** or **Ca** **Cancel**.

Language

When the phone is first installed, it is set to display screen text in English. You can select the language that you would prefer from the following:











- English, German (Deutsch), French (Français), Spanish (Español), Italian (Italiano), Dutch (Nederlands), Portuguese (Português) or Japanese (Katakana characters).

Note: This does not alter your user language setting on the telephone system.

1. Press **→** **Exit** to exit any other mode. Press **Op** **Option**.
2. Press **Er** **Language**. A menu listing the available languages appears, with the current language underlined.
3. Press the **Er** or **Ca** key next to the language required. The screen text changes to the language selected.
4. Do one of the following:
 - To save the settings and return to the options menu, press **Sa** **Save**. You will hear a confirmation tone.
 - To return to the options menu without saving any changes, press **Ca** **Cancel**.
 - To return to the call handling screen without saving any changes, press **→**.

Automatic Gain Control (AGC)

Automatic Gain Control (AGC) raises the volume when a caller is speaking quietly and lowers the volume when the caller is loud.

1. Press  **Exit** to exit any other mode. Press  **Option**.
2. Press a  or  key until a menu listing the current handset, headset and speaker AGC options is displayed.
3. To toggle a particular setting between **Yes** and **No**, press the  key next to it.
 - Alternatively, press the  key next to a call type to underline its current setting and then press  **Yes/No** to change the value of the currently underlined setting.
4. Do one of the following:
 - To save the settings and return to the options menu, press  **Save**. You will hear a confirmation tone.
 - To return to the options menu without saving any changes, press  **Cancel**.
 - To return to the call handling screen without saving any changes, press  **Exit**.

System Features

System Features

As well as your phones specific features, you can access a number of system features by dialing short codes.

These instructions are for the system's default configuration. They assume that you are using the default feature codes. It also assumes that you have full access to all features and the public telephone network.

Making Calls

Internal Calls:

If your System Administrator has allocated you the *Ring Back When Free* feature (see RBak+ - Ringback When Free) under a dial pad digit, you can:

1. When you call an extension that does not answer or is busy, press the  **RBak** feature key to set a callback on that extension.
2. When the extension you called becomes free, your phone will ring (a burst of three rings).
3. Lift the handset and the extension is called automatically.
4. When the extension you called is free, your phone will ring (a burst of three rings).
5. Lift the handset and the extension is called automatically.

External calls:

To make an external call, either dial the number (prefixed by the access code if required) or use a speed dial code (contact your system manager for a list of your speed codes).

If you hear busy tone while dialing, then the call may be barred. Your system manager can bar certain calls, such as those to premium rate numbers and international calls.

Answering Calls

Ringling at your own extension:

Simply pick up the handset. When in headset mode, press the button associated with the alerting call.

The default ringing cadences are:

- Internal calls have a single ring cadence
- External calls have a double ring cadence.

These can be changed by your System Administrator.

Ringling at another extension:

You can answer from your own phone by using Call Pick-Up; lift your handset and dial:

- ***30** to answer a call ringing anywhere.
- ***31** to answer a call within your group.
- ***32*201#** to answer the call for a particular extension, in this example 201.

Note: If your phone rings for any longer than a specified period (15 seconds in default), any re-direction feature that you have activated, such as voicemail or call forwarding, will come into effect.

Call Forwarding

Your calls can be forwarded to another extension or an external number either when you are away from your desk (on no answer), when your extension is busy, and all calls (for example when you go on holiday).

- To switch forward direct station (i.e. not Hunt Group) calls on dial ***01**, to switch it off dial ***02**.
- To switch forward on busy on dial ***03**, to switch it off dial ***04**.
- To switch forward on no answer on dial ***05**, to switch it off dial ***06**.
- To set the number to which your calls are forwarded dial ***07*201#**, forwarding to 201 in this example.

Diverting Calls

You can divert your calls to another extension. In the examples below **N** is the extension to which you want your calls diverted. Note that, if you do not answer calls at the temporary extension, they are forwarded to your own voicemail or call forwarding number.

At another extension:

- ***12*N#** from the extension you are temporarily using.
- ***13*N#** to re-direct the calls back to your own extension, before you return to it.

At your own extension:

- ***14*N#** from your own extension.
- ***14*#** to cancel either feature from your own extension.

Do Not Disturb

You may choose to receive no calls at all or only those from particular callers on your exceptions list:

To switch Do Not Disturb on (with or without exceptions) dial ***08**, to switch it off dial ***09**.

- ***10*N#** to add a number to the exception list.
- ***11*N#** to delete a number from the exception list.

Note: Your callers, other than your exceptions, either hear busy tone or are re-directed to your voicemail.

Voicemail

Note that not all systems support voicemail or have voicemail installed.

- To switch voicemail on dial ***18**, to switch it off dial ***19**.
- To retrieve your voicemail, use the code ***17**.

Your voicemail may be set up to deliver your messages by calling you whenever you hang up: this feature is known as *Voicemail Ringback*.

- To turn Voicemail Ringback on dial ***48**; to turn it off dial ***49**.

Dialing a number while listening to your messages invokes further facilities:

Once messages have been delivered, they are held on the system for 24 hours (this is fixed for Voicemail Lite, but can be varied by your System Administrator if your IP Office is equipped with VoicemailPro).

You can collect your voicemail from another extension by using the PIN your System Administrator has set up for you. You can collect your messages if you are out of the office, by either dialing from a number that has been registered for the purpose or by dialing your extension number and PIN when prompted. If validation is successful, then dial **1** to retrieve your mail.

The System Administrator also specifies the reception number, to which the call is diverted if the caller dials **0**, and your email address if your voicemail and email are integrated.

Default Feature Codes

The following are the normal default feature codes available to all users. Your System Administrator may add additional codes for other features and for speed dials.

The **N** where shown, should be replaced by the appropriate number. For example, with ***07*N#**, replace **N** with the extension to which you want your calls forwarded when you have forwarding switched on.

*00	Cancel All Forwarding	*32*N#	Call Pick Up Extension
*01	Forward Unconditionally On	*33*N#	Call Queue
*02	Forward Unconditionally Off	*34	Hold Music
*03	Forward on Busy On	*35*N#	Extn Login
*04	Forward on Busy Off	*36*N#	Extn Logout
*05	Forward on No Answer On	*37*N#	Park Call
*06	Forward on No Answer Off	*38*N#	Ride Call
*07*N#	Forward to number	*39	Relay On
*08	Do Not Disturb On	*40	Relay Off
*09	Do Not Disturb Off	*41	Relay Pulse
*10*N#	Do Not Disturb Exception Add	*42	Relay On
*11*N#	Do Not Disturb Exception Delete	*43	Relay Off
*12*N#	Follow Me Here	*44	Relay Pulse
*13*N#	Follow Me Here Cancel	*45*N#	Call Steal
*14*N#	Follow Me To	*46	Call Steal
*15	Call Waiting On	*47	Conference Add
*16	Call Waiting Off	*48	Voicemail Ringback On
*17	Voicemail Collect	*49	Voicemail Ringback Off
*18	Voicemail On	*50	Forward Hunt Group Calls On
*19	Voicemail Off	*51	Forward Hunt Group Calls Off
*20*N#	Set Hunt Group Night Service	*52	Clear Call
*21*N#	Clear Hunt Group Night Service	*53*N#	Call Pickup Members
*29	Toggle Calls	*57*N#	Forward on busy number
*30	Call Pick Up Any	*70*N#	Dial Physical Extn by Number
*31	Call Pick Up Group	*71*N#	Dial Physical Extn by ID

EU24 Expansion Module

EU24 Overview

The EU24 Expansion Module is an optional device that can be connected to your 2420/5420 phone to extend the number of call appearance and feature buttons available on the telephone.

The expansion module has 24 buttons arranged in two columns. Depending on how they have been programmed by your System Administrator, these buttons can be used for call appearances or features. You can adjust the viewing angle of the EU24 display to match that of your phone.

The following figure shows a top view of the EU24 (the left hand column is displayed).

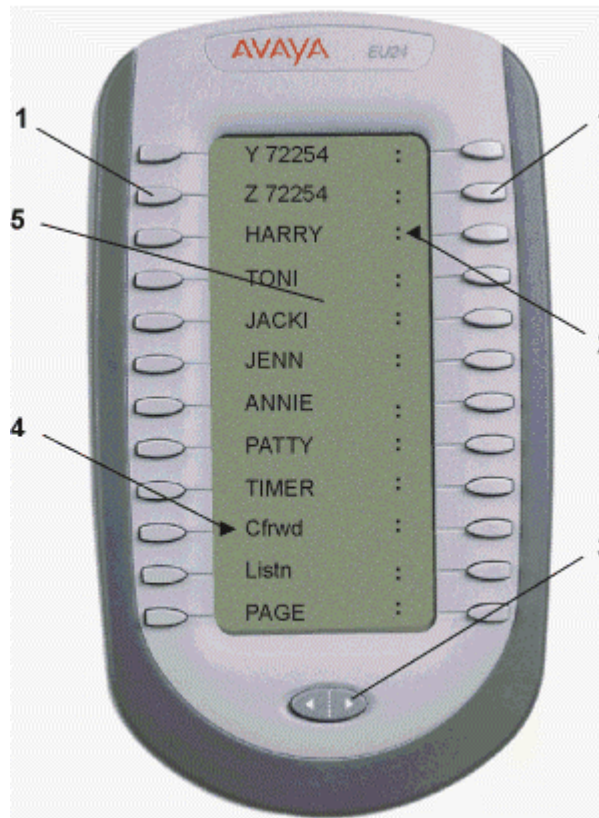

1. Call Appearance/Feature Button.
2. Feature Active icon for feature in right column.
3. Alternate Display Button
4. Feature Active icon for feature in left column.
5. Display.

Connection

Before you can begin using the EU24 Expansion Module, the module must be connected to the phone according to the instructions in the *EU24 Expansion Module Installation and Safety Instructions* (555-233-136).



Using the EU24 Expansion Module

The following sections explain how to use the features of the EU24 Expansion Module. For more information, consult your System Administrator.

Viewing the Alternate Display

Although the EU24 Expansion Module supports an additional 24 call appearance/feature buttons, it only displays the button labels and icons for one column at a time. A dotted line separates the left column from the right column.

When you are viewing the labels and icons for the left column, the icons for the right column are displayed to the right of the dotted line. To view the column not currently displayed, press the Alternate Display button.

Selecting a Call Appearance/Feature Button

To select an available call appearance or feature, press the button next to the label in the column currently displayed.

If the call appearance or feature is not currently displayed, use the Alternate Display key to access the additional 12 call appearance/feature button labels.

Understanding Call Appearance/Feature Button Status Icons

When a call arrives for a call appearance on the EU24 Expansion Module, the bell icon blinks on the corresponding call appearance. To answer the call, press the button associated with the call appearance.

The icons displayed on the call appearance allow you to determine the status (for example, on hold) of each call on the EU24 Expansion Module. Icons also indicate whether a feature has been administered for a particular button on the EU24 Expansion Module. For an explanation of these icons see Call Appearance Keys.

Index

- 0**
- 07*N 27
- 1**
- 1.5
 - enter 16
- 10*N 25, 27
- 11*N 25, 27
- 12*N 25, 27
- 13*N 25, 27
- 14*N 25, 27
- 2**
- 20*N 27
- 201
 - forwarding 25
- 21*N 27
- 3**
- 32*N 27
- 33*N 27
- 35*N 27
- 36*N 27
- 37*N 27
- 38*N 27
- 4**
- 45*N 27
- 5**
- 53*N 27
- 57*N 27
- 7**
- 70*N 27
- 71*N 27
- A**
- Access
 - Call Log 8, 9
 - speakerphone 4
 - Speed Dial List 8, 9
- Access 4
- Access 8
- Access 9
- Add
 - New Speed Dial 16
 - Pressing 14
- Add 14
- Add 16
- Adjust speakerphone 8
- Adjusting
 - Display Contrast 21
 - speakerphone 10
- Adjusting 10
- Adjusting 21
- Administrator' 7
- Affect
 - voicemail 20
- Affect 20
- AGC 23
- All 17, 18, 19
- All Logged Calls
 - Erasing 19
- All Logged Calls 19
- Alternate Display
 - Viewing 30
- Alternate Display 30
- Alternate Display button
 - press 30
- Alternate Display button 28
- Alternate Display button 30
- Alternate Display key
 - use 30
- Alternate Display key 30
- Answer
 - Call 8, 24
 - showing 19
- Answer 8
- Answer 19
- Answer 24
- Answer/make 6
- Answered, Un-answered 17
- Appearance/feature 30
- Appearance/feature button 30
- Automatic Gain Control 23
- Avaya 4
- Avaya 5420 4
- Avaya IP Office 4
- B**
- Back 18, 19
- Backspace 16
- Bridged 6
- Bridged Appearance 6
- Busy Off 27
- Busy On 27
- C**
- Call Appearance 6, 13
- Call Appearance button
 - pressing 11
- Call Appearance button 11
- Call Appearance Keys
 - replace 6
- Call Appearance Keys 4
- Call Appearance Keys 6
- Call Appearance Keys 11
- Call Appearance Keys Icons 7
- Call Appearance/Feature Button
 - Selecting 30
- Call Appearance/Feature Button 28
- Call Appearance/Feature Button Status Icons
 - Understanding 30
- Call Appearance/Feature Button Status Icons 30
- Call Appearance/Feature Keys 7
- Call Coverage
 - Appearance 6
- Call Coverage Appearance 6
- Call Coverage Appearance Keys 6
- Call Forwarding 25
- Call Handling Buttons 4
- Call Log
 - Access 8, 9
 - Overview 17
 - Viewing 18
- Call Log 4
- Call Log 8
- Call Log 9
- Call Log 17
- Call Log 18
- Call Log 18
- Call Log 19
- Call Log 20
- Call Log 22
- Call Log Entry
 - Converting 15
 - Deleting 19
 - Saving 18
- Call Log Entry 15
- Call Log Entry 18
- Call Log Entry 19
- Call Log Setup 21
- Call Pick Up Any 27
- Call Pick Up Extension 27
- Call Pick Up Group 27
- Call Pick-Up 24
- Call Pickup Members 27
- Call Queue 27
- Call Steal 27
- Call Waiting Off 27
- Call Waiting On 27
- Calls
 - Answer 8
 - Answering 24
 - Clearing 9
 - Diverting 25
 - Incoming 7
 - Make 8
 - Making 18, 24
- Calls 7
- Calls 8
- Calls 8
- Calls 9
- Calls 18
- Calls 24
- Calls 24
- Calls 25
- Cancel 15, 16, 19, 20, 22, 23
- Cancel All Forwarding 27
- Case 16
- CAUTIONS 6
- Clear Call 27
- Clear Hunt Group Night Service 27
- Clearing
 - Call 9
- Clearing 9
- Colleague's 6
- Conference 12, 13
- Conference Add 27
- Connection 29
- Converting
 - Call Log Entry 15
- Converting 15
- D**
- Default Feature Codes 27
- Default Phone/Erase All Settings 22
- Deleting
 - Call Log Entry 19
 - Speed Dial 15
- Deleting 15
- Deleting 19
- Deutsch 22
- Dial
 - Speed Dial Number 14
- Dial 14
- Dial Physical Extn 27
- Display Contrast
 - Adjusting 21
- Display Contrast 21
- Display Mode
 - Selecting 21
- Display Mode 21
- Display, Call Appearance 4
- Diverting

Calls 25
 Diverting 25
 Do Not Disturb 25
 Done
 pressing 21
 Done 15, 18
 Done 21
 Done 21
 Drop 8, 12, 13
E
 Edit
 Speed Dial 15
 Edit 14
 Edit 15
 Either Logging 17
 Email 26
 End
 speakerphone 10
 End 10
 English 22
 Entering
 1.5 16
 Entering 16
 Erase All 19, 22
 Erasing
 All Logged Calls
 19
 Erasing 19
 Español 22
 EU24
 view 28
 EU24 28
 EU24 Expansion
 Module
 Using 30
 EU24 Expansion
 Module 28, 29
 EU24 Expansion
 Module 30
 EU24 Expansion
 Module Installation
 29
 EU24 Overview 28
 Exit
 pressing 21
 Exit 8, 14, 16, 19
 Exit 21
 Exit 23
 Extn Login 27
 Extn Logout 27
F
 Feature 4
 Feature Active icon
 28
 Flash Message
 Lamp
 set 20
 Yes 20
 Flash Message
 Lamp 20
 Follow Me Here 27
 Follow Me Here
 Cancel 27

Follow Me To 27
 Forward Hunt Group
 Calls Off 27
 Forward Hunt Group
 Calls On 27
 Forward
 Unconditionally Off
 27
 Forward
 Unconditionally On
 27
 Forwarding
 201 25
 Forwarding 25
 Français 22
 Function Active 7
 Function Keys 7

G
 German 22
H
 Headset 9, 10
 Headset Working 9
 Hold
 Test key 21
 Hold 7, 11, 12
 Hold 21
 Hold Music 27
 Home 8, 10
 Hunt Group 25
 Hyphen 16

I
 ID 27
 InAns 17, 18, 19
 Incoming
 Call 7
 Incoming 7
 Internal Calls 24
 IP 6
 IP Office 4, 6, 17, 26
 IP Office Key
 refer 6
 IP Office Key 6
 Italian 22
 Italiano 22

J
 Japanese 22

K
 Katakana 22
L
 Lamp Operation 6
 Language 22
 LED 10
 Line 6
 Line Appearance 6
 Log
 pressing 17
 Log 17
 Log 18
 Log 18
 Log 18
 Log 18
 Log 19

Log 19
M
 Making
 Call 8
 Calls 18, 24
 Making 8
 Making 18
 Making 24
 Menu
 Speed Dial list 21
 Message 13, 20
 Message button
 Press 13
 Message button 13
 Miscellaneous 21
 Missed
 return 18, 19
 Missed 18
 Missed 18
 Missed 18
 Missed 19
 Mode' 9
 More 17, 18, 19
 Mute 11
 Mute button 11
N
 Name 16
 Nederlands 22
 New Speed Dial
 Adding 16
 New Speed Dial 16
 No Answer Off 27
 No Answer On 27
 Not Disturb 25
 Not Disturb
 Exception Add 27
 Not Disturb
 Exception Delete 27
 Not Disturb Off 27
 Not Disturb On 27
 Number
 System Features
 7
 Number 7
 Number 16
 Number 27
O
 On/off 4
 Option 19, 20, 22
 Option menu
 return 19
 Option menu 19
 Option menu 21
 Outg 18, 19
 Outgo 17, 18, 19
 Overview
 Call Log 17
 Speed Dials 14
 Overview 4
 Overview 14
 Overview 17

P
 Park Call 27
 Pause 16
 Personalization 19
 PIN 26
 Play 20
 Português 22
 Portuguese 22
 Press Add 16
 Press Call 18
 Press Conference 13
 Press Contrast 21
 Press Delete 15, 19
 Press Done 18
 Press Drop 9
 Press Edit 15
 Press Erase 19, 22
 Press Exit 20, 21,
 22, 23
 Press Hold 11
 Press Language 22
 Press Log 18, 19
 Press Log Setup 19
 Press Miscellaneous
 21
 Press Mute 11
 Press Option 19, 20,
 21, 22, 23
 Press Redial 8, 9, 10
 Press Ring Options
 20
 Press Save 18
 Press Self Test 21
 Press SpDial 14, 15,
 16
 Press Speaker 10
 Press Yes 15
 Pressing
 Add 14
 Alternate Display
 button 30
 Call Appearance
 button 11
 Done 21
 Exit 21
 Log 17
 Message button
 13
 RBak 24
 SpDial 14
 SpDial softkey 10
 Speaker 8, 18
 Pressing 8
 Pressing 10
 Pressing 11
 Pressing 13
 Pressing 14
 Pressing 17
 Pressing 18
 Pressing 21
 Pressing 24
 Pressing 30
 Previous/Next Page
 4

- R**
- RBak
 - press 24
 - RBak 24
 - Redial 4, 10
 - Redial list 10
 - Redials 10
 - Refer
 - IP Office Key 6
 - Refer 6
 - Relay Off 27
 - Relay On 27
 - Relay Pulse 27
 - Replace
 - Call Appearance Keys 6
 - Replace 6
 - Return
 - Missed 18, 19
 - Options menu 19
 - Return 18
 - Return 18
 - Return 18
 - Return 19
 - Return 19
 - Ride Call 27
 - Ring Back When Free 24
 - Ring Options 20
 - Ring Pattern 20
- S**
- Safety Instructions 29
 - Save
 - Call Log Entry 18
 - Save 16
 - Save 18
 - Save 19
 - Save 20
 - Save 22
 - Save 23
 - Select/de-select 22
 - Selecting
 - Call Appearance/Feature Button 30
 - Display Mode 21
 - Selecting 21
 - Selecting 30
 - Set
 - Flash Message Lamp 20
 - Show Phone Screen 20
 - up/using Speed Dial 20
 - Which Calls 19
 - Yes 20, 21
 - Set 19
 - Set 20
 - Set 21
 - Set Hunt Group
 - Night Service 27
 - Show Phone Screen
 - set 20
 - Yes 20
 - Show Phone Screen 20
 - Showing
 - Answered 19
 - Showing 19
 - Softkeys 4
 - Space 16
 - Spanish 22
 - SpDial
 - pressing 14
 - SpDial 14
 - SpDial 14
 - SpDial 15
 - SpDial 15
 - SpDial 16
 - SpDial 17
 - SpDial 22
 - SpDial softkey
 - press 10
 - SpDial softkey 10
 - Speaker
 - pressing 8, 18
 - Speaker 8
 - Speaker 18
 - Speakerphone
 - Access 4
 - Adjust 10
 - end 10
 - use 10
 - Speakerphone 4
 - Speakerphone 8
 - Speakerphone 10
 - Speakerphone 11
 - Speakerphones 10
 - Speed Dial List
 - Access 8, 9
 - menu 21
 - Speed Dial List 8
 - Speed Dial List 9
 - Speed Dial List 21
 - Speed Dial Number
 - Dialing 14
 - Speed Dial Number 14
 - Speed Dials
 - Deleting 15
 - Editing 15
 - Overview 14
 - Yes 21
 - Speed Dials 4, 10
 - Speed Dials 14
 - Speed Dials 15
 - Speed Dials 15
 - Speed Dials 15
 - Speed Dials 21
 - Speed Dials 22
 - Standard 12-button 4
 - Stay 21
 - System
 - Administrator 4, 6, 7, 11, 24, 26, 27, 28, 30
 - System Features
 - number 7
 - System Features 6
 - System Features 7
 - System Features 24
- T**
- Test key
 - hold 21
 - Test key 21
 - Toggle Calls 27
 - Transfer 12
- U**
- Un-Answered 19
 - Understanding
 - Call Appearance/Feature Button Status Icons 30
 - Understanding 30
 - Up/using Speed Dial
 - setting 20
 - Up/using Speed Dial 20
 - Use
 - Alternate Display key 30
 - speakerphone 10
 - Use 10
 - Use 30
 - User Labels 22
 - Using
 - EU24 Expansion Module 30
 - Using 30
 - Using Self Test 21
- V**
- Viewing
 - Alternate Display 30
 - Call Log 18
 - EU24 28
 - Viewing 18
 - Viewing 28
 - Viewing 30
 - Voicemail
 - affect 20
 - Voicemail 4, 7
 - Voicemail 20
 - Voicemail 24
 - Voicemail 25
 - Voicemail 25
 - Voicemail 26
 - Voicemail Collect 27
 - Voicemail Lite 26
 - Voicemail Off 27
 - Voicemail On 27
 - Voicemail ringback 26
 - Voicemail Ringback Off 27
 - Voicemail Ringback On 27
 - VoicemailPro 26
 - Volume Controls 4
- W**
- WARNING 17
 - Which Calls
 - Setting 19
 - Which Calls 19
- Y**
- Yes
 - Flash Message Lamp 20
 - set 20, 21
 - Show Phone Screen 20
 - Speed Dial 21
 - Yes 19
 - Yes 20
 - Yes 21
 - Yes 23
 - Yes/No 19, 23
 - Your Speed Dial List 18

Performance figures and data quoted in this document are typical, and must be specifically confirmed in writing by Avaya before they become applicable to any particular order or contract.

The company reserves the right to make alterations or amendments to the detailed specifications at its discretion. The publication of information in this document does not imply freedom from patent or other protective rights of Avaya or others.

Intellectual property related to this product (including trademarks) and registered to Lucent Technologies have been transferred or licensed to Avaya.

All trademarks identified by the ® or ™ are registered trademarks or trademarks, respectively, of Avaya Inc. All other trademarks are the property of their respective owners.

This document contains proprietary information of Avaya and is not to be disclosed or used except in accordance with applicable agreements.

Any comments or suggestions regarding this document should be sent to "wgctechpubs@avaya.com".

© 2005 Avaya Inc. All rights reserved.

Avaya
Sterling Court
15 - 21 Mundells
Welwyn Garden City
Hertfordshire
AL7 1LZ
England

Tel: +44 (0) 1707 392200

Fax: +44 (0) 1707 376933

Web: <http://www.avaya.com>